



PUERTAS CORREDERAS



ALUMINIO

PALANCA GANCHO ENTRE EJES 85 mm.

SERIE 198K

CARACTERÍSTICAS

- Frente inox de 16 mm ó 22 mm
- Caja de 15 mm
- 2 escudos de nylon ref. ES1984
- Tornillo de fijación de cilindro

ACCESORIOS OPCIONALES

- Gama completa de cilindros (ver página 119 - 140)

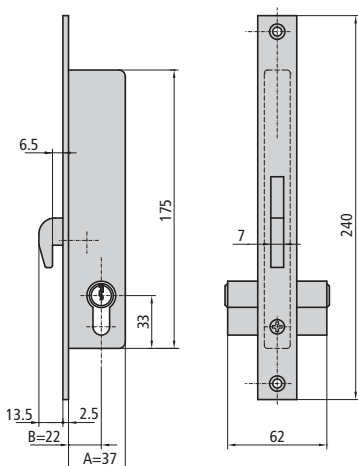

DESCRIPCIÓN

REF.

MEDIDAS B A

LEVA

ACABADOS FRENTE CILINDRO

UDS

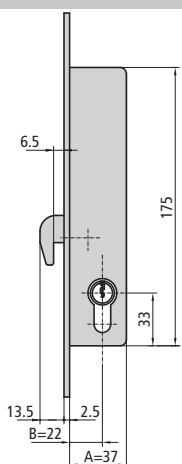

- Cerradura para puerta corredera
- Sólo palanca gancho
- Cilindro de leva larga 5982/2525/4

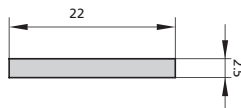
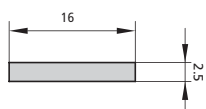

P198K25/6	22	37	15	AI	CN	1	20
P198K30/6	27	42	15	AI	CN	1	20
P198K35/6	32	47	15	AI	CN	1	20

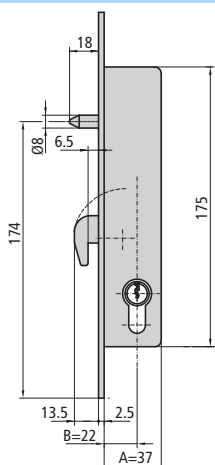

- Cerradura para puerta corredera
- Sólo palanca gancho con pin de seguridad
- Cilindro de leva larga 5982/2525/4

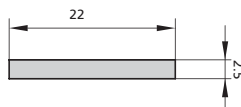
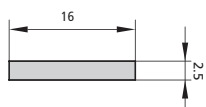

P198KB25/6	22	37	15	AI	CN	1	20
P198KB30/6	27	42	15	AI	CN	1	20
P198KB35/6	32	47	15	AI	CN	1	20

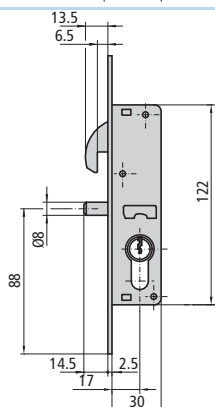

- Cerradura para puerta corredera
- Sólo palanca gancho
- Pin deslizantes
- Cilindro de leva corta 5990/2525/4

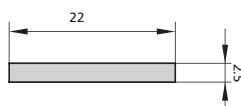
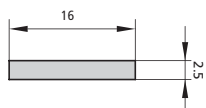

P198KD20/6	17	30	13,25	AI	CN	1	20
198KD20/6	17	30	13,25	AI	CN	1	20